Comfort-Aire®

 **Century**®

MARS®
Delivering Confidence

REPLACEMENT PARTS LIST

Inverter Single Zone Ductless Mini-Split

B-ZHP09SA-1

EXPLODED VIEW

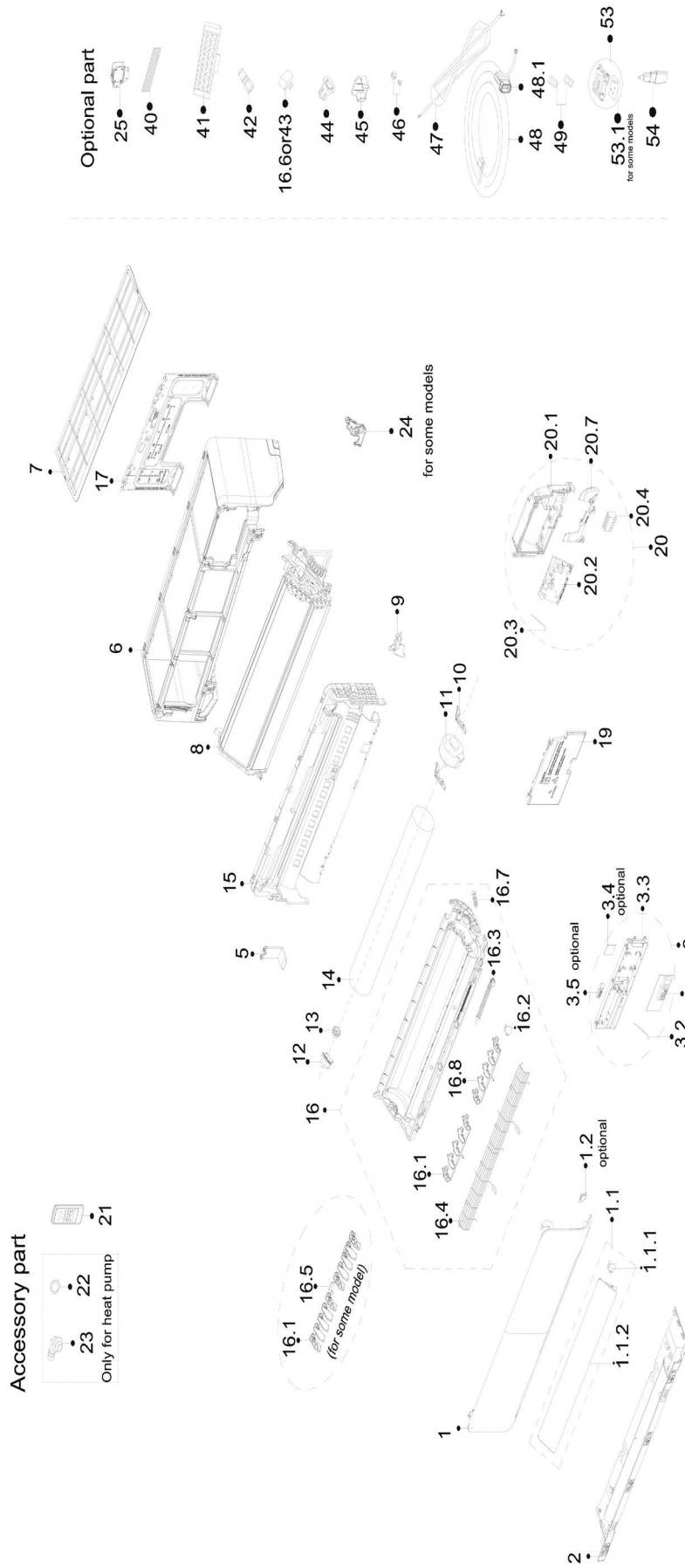

REPLACEMENT PARTS

Location	Part Name	Quantity	Part No.
1	Panel assembly	1.0	12122000027561
1.1	Panel assembly	1.0	12122000027562
1.1.1	Stepper motor	1.0	11002010001446
1.1.2	Horizontal louver	1.0	12122000027035
2	Panel assembly	1.0	12122000027037
3	Display box assembly	1.0	17222000044153
3.1	Display board assembly	1.0	17122000062305
3.2	Ambient temperature sensor subassembly	1.0	11201007003103
3.3	Display box	1.0	12122000026921
3.5	adapter board subassembly	1.0	17122000063852
5	Chassis supporter	1.0	12122000026621
6	Panel frame assembly	1.0	12122000027027
7	Air filter	1.0	12122000027040
8	evaporator assembly	1.0	15822000015826
9	Pipe clamp board	1.0	12122000027026
10	Fixing plate for fan motor	2.0	12122000011994
11	Motor	1.0	11002015021815
12	bearing holder	1.0	12122000000350
13	bearing base	1.0	12622000000131
14	Cross flow fan	1.0	12100102000131
15	Chassis assemble((above))	1.0	12122000027029
16	Chassis assemble((below))	1.0	12122000027682
16.1	louver	6.0	12122000026617
16.2	Stepper motor	1.0	11002010001486
16.3	Drain pipe joint	1.0	12100501000032
16.4	Air outlet Protective wire	1.0	12222000014325
16.5	Connecting rod of louver	1.0	12122000027024
16.7	Drainage plug	1.0	12622000000030
16.8	louver	6.0	12122000026616
17	Installation plate	1.0	12222000A06971
19	Cover of electronic control box	1.0	12122000026601
20	Structural components of indoor electric control box	1.0	17222000044079
20.1	Electronic control box	1.0	12122000026606
20.2	Indoor main control board subassembly	1.0	17122000063927
20.3	Pipe temperature sensor subassembly	1.0	11201007003445
20.4	Terminal block	1.0	17400401000577
20.7	Electric control box bracket	1.0	12122000026605
21	remote controller	1.0	17317000012079
24	Ratproof plate subassembly	1.0	12122000028101
25	Gas sensor	1.0	11201003000364
40	Air freshening filter	1.0	12100204000685
42	Detection valve	1.0	15500209000001
46	Copper nut	1.0	15500406000016
46	Copper nut	1.0	15500406000010

Due to ongoing product improvements, specifications and dimensions are subject to change and correction without notice or incurring obligations. Determining the application and suitability for use of any product is the responsibility of the installer. Additionally, the installer is responsible for verifying dimensional data on the actual product prior to beginning any installation preparations.

Incentive and rebate programs have precise requirements as to product performance and certification. All products meet applicable regulations in effect on date of manufacture; however, certifications are not necessarily granted for the life of a product. Therefore, it is the responsibility of the applicant to determine whether a specific model qualifies for these incentive/rebate programs.

Comfort-Cire®  **Century**®

1900 Wellworth Ave., Jackson, MI 49203 • Ph. 517-787-2100 • www.marsdelivers.com

